

# FILL-RITE®

The Most Trusted Name in Pumps and Meters

## FR610G Series Technical Specifications

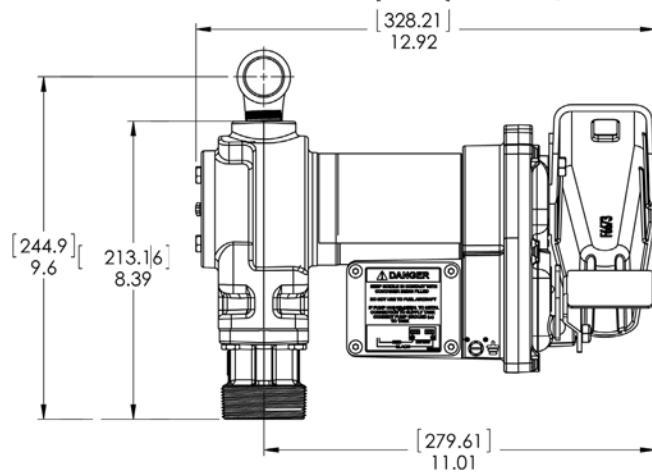
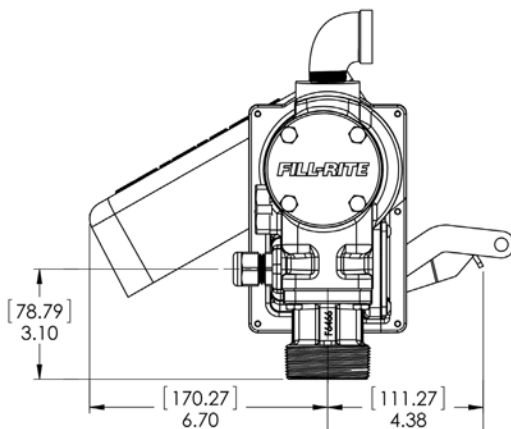
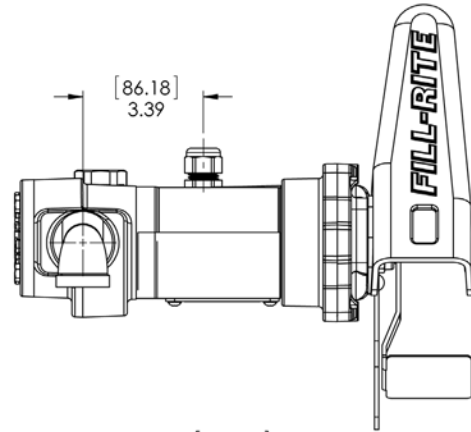

Pump		Motor	
Type - Rotary, Diaphragm, Gear, Vane	Rotary Vane	Power - AC 115,230, 115/230	115
GPM in Supplied Configuration	14.8	HZ 50,60,50/60	60
GPM Open Flow - no Hose or Nozzle	17.4	Power - DC 12, 24, 12/24	N/A
By-Pass Pressure Rating (PSI) - Max	16 PSI	HP (Horsepower) Rating	1/6 HP
Dry Vac (in Hg)	5	Power Cord Length (feet)	N/A
Head - Max (Ft.)	36.96	Power Cord Gauge (AWG)	N/A
Anti-Siphon Valve	None	DC Power Cord Connectors	None
Inlet - Size / Thread	1"	Amps (FLA)	2.0
Outlet - Size / Thread	NPT	RPM	2000
Mount	Bung	Duty Cycle	30 min.
Material - Pump Housing	Cast Iron	Thermal Protection Switch	Yes
Material - Wetted Material	Buna	Circuit Protection Fuse	None
Rotor Material	Powdered Iron	Certification	UL, cUL
Rotor Vane Material	Bronze		
Compatible Fluids	Diesel, Gasoline, BioDiesel up to B20		
Strainer Mesh Size	20 X 20		
Warranty	2 Years		



Excellence at work. Excellence in life.

## 600 SERIES PERFORMANCE CURVE

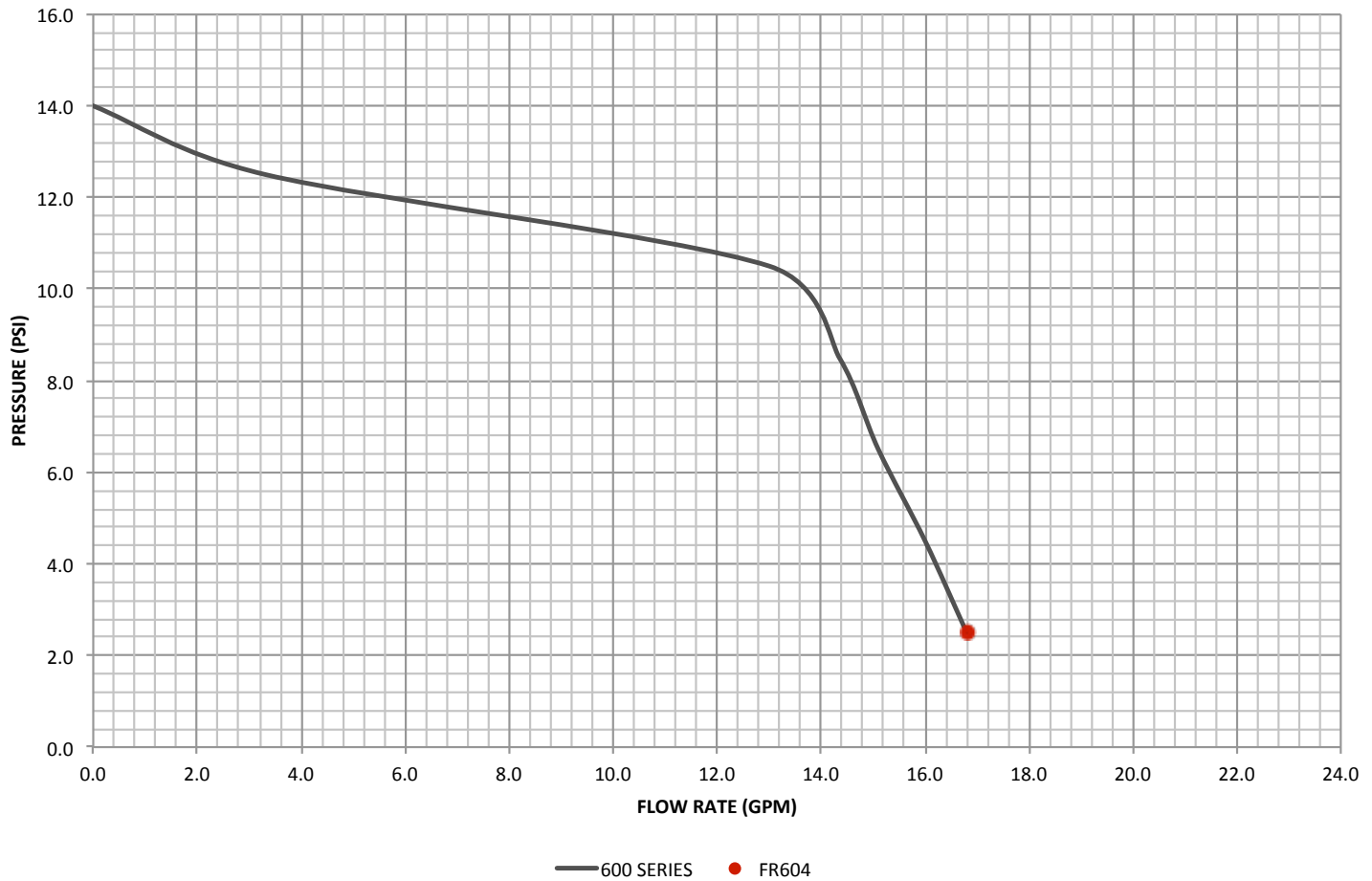

### SERVICE KIT INFORMATION

Kit	Description	Parts
KIT120BD	BioDiesel Kit	O-ring seal, bypass valve poppet, bypass cap seal, inlet seal
KIT120RG	Rotor & Vane Kit	Rotor cover, rotor, vanes, rotor key, O-ring seal, attaching hardware
KIT120JC	Junction Cover Kit	Junction cover, seal
KIT120SL	Seal Kit	O-ring, shaft seals, retainer clip
KIT120BV	By-Pass Service Kit	Screen, bypass valve, valve spring, bypass cap, O-ring seal
KIT120NB	Nozzle Boot Kit	Nozzle boot, attaching hardware
KIT120BG	Inlet Flange Kit	Inlet flange (bung), attaching hardware, inlet seal, screen
KIT120SG	Inlet Gasket & Screen	Gasket for inlet (bung) and screen
KIT120SW	Switch Lever Kit	Switch lever, mounting hardware

### Accessories

Suction pipe material	Steel
Suction pipe length - extended/notextended	40.5 / 23
Nozzle - size	3/4"
Nozzle - Manual / Automatic	Manual
Hose liquid materials compatibility	Black Nitrile Rubber
Hose diameter	3/4"
Hose length	12'
Hose static wire (Y/N)	Yes

### Logistics

UPC	0-89404-22324-6
Freight Class of Product (Number Only)	85
Length	17
Width	15
Height	15